

ZAHNRADUEBERSETZUNG SA-MASCHINE

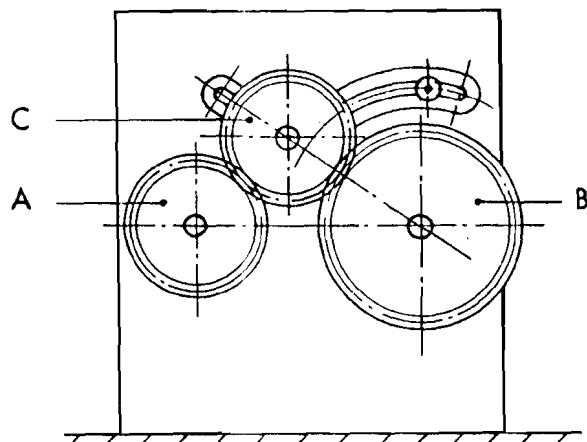

EINFACHE UEBERSETZUNG

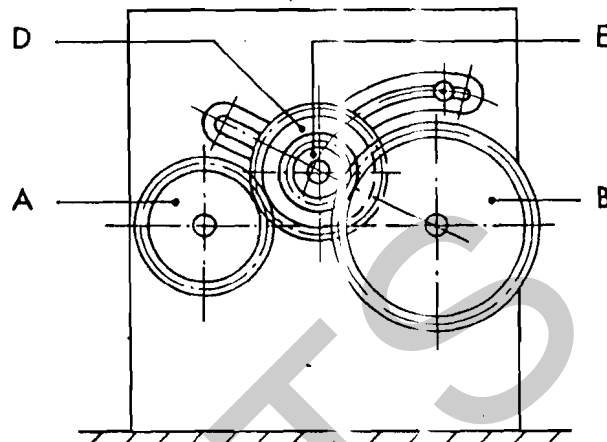

DOPPELUEBERSETZUNG

NOCKENANORDNUNG

Steppen ohne Stichaussgleich

Steppen mit Stichaussgleich

Nocke Transport: SN 10 für alle Muster

Nocke Transport: SN... je nach Muster

Nocke Dessin : SN... je nach Muster

Nocke Dessin : SN... je nach Muster

Alle nicht aufgeführten Uebersetzungen nur auf Wunsch.









Zahnrad C kann beliebig gewählt werden.

Bestell-No. 10755/SA + Zähnezahl

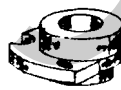



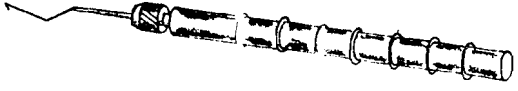

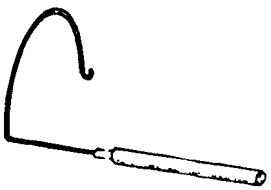
Stichzahl auf 6"	A	B	D	E
30	40	30		
32	40	32		
36	40	36		
48	40	48		
54	40	54		
60	40	60		
72	40	72		
78	40	78		
80	40	80		
	20	40		
84	40	84		
90	40	90		
120	20	60		
160	20	80		
200	48	80	60	20
240	40	80	60	20
	30	60	60	20

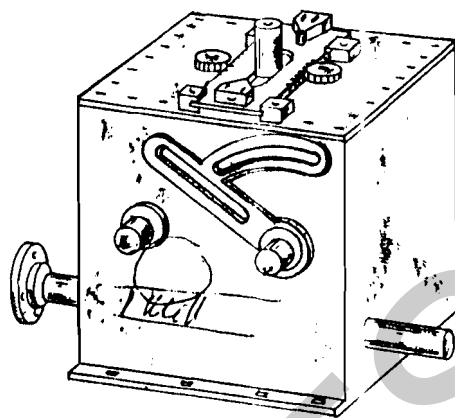
STEPPMASCHINEN-ERSATZTEILE
 OEHLER AG AU SG POSTFACH 5 SCHWEIZ

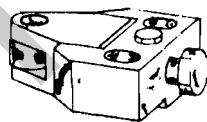
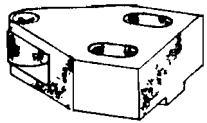
STEPPEX

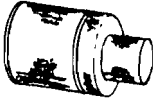

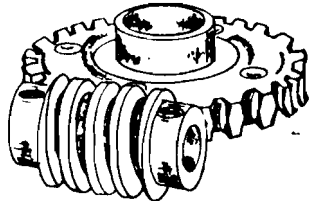

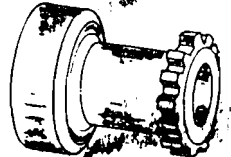





100	11931 11897	Nockenflanschkompl. mit Schrauben und Sternstück 10541, \varnothing 30 do., \varnothing 35	
	10541	Sternstück allein	
SA4-V 100	12382	Fühlerrolle komplett für Innenbahn-Nocken	
SA/SA4 100	12536 12498	Nockenflansch kompl. für Innenbahn-Nocken mit Schrauben und Sternstück, \varnothing 30 do., \varnothing 35	
ST	10075	Lagerbüchse für Nockenwelle	
	OAG 7230	Schiffplinagel	
	56850	Schiffchen gross No 10	
	56883	Schiffchen Twin normal No 7	
	56856	Schiffchen Twin links No 7	
	OAG 7034 52037	Fädelhäkchenhalter Plastik, kurz Fädelhäkchenhalter Plastik, lang	
	OAG 7030	Einfädelhäkchen	
		55 mm lang sehr fein 2331F 80/0 \varnothing 0,8 mittelfein 2331F 90/1/2 \varnothing 0,9 normal 2331F 110/2 \varnothing 1,1 grob 2331F 120/3 \varnothing 1,2 sehr grob 2331F 130/4 \varnothing 1,3 Twin links 2331FR 90/1/2 \varnothing 0,9 Twin links 2331FR 110/2 \varnothing 1,1 62 mm lang R/P 100 2331F 110/2/lang \varnothing 1,1 2331F 130/lang \varnothing 1,3 2345F 160/lang \varnothing 1,6	 
	12795	Einfädler für Fadenwächter	

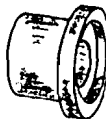

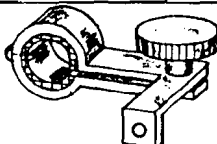

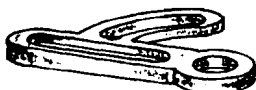

	11162	Federfühler komplett	
SA4 V 100	11161	Fühler fest, komplett	
	11859	Tellerfeder Ø 22,5 zu 11162	
ST SA 4	11858	Fühler montiert	
SA	11857	Rollkupplung mit Glockenzahn- kranz und Welle montiert Gültig bis Maschine No 404	
	12529	Schneckenrad mit Schnecke eingeschliffen	
SA SA V 100	52402 52400	Gelenkwelle Gelenkwelle	
SA 4 100	11835 12575	Rollkupplung mit Glockenzahn- kranz montiert* *Gültig ab Maschine No 405	

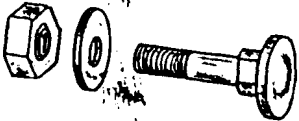
STEPPMASCHINEN-ERSATZTEILE
 OEHLER AG AU SG POSTFACH 5 SCHWEIZ

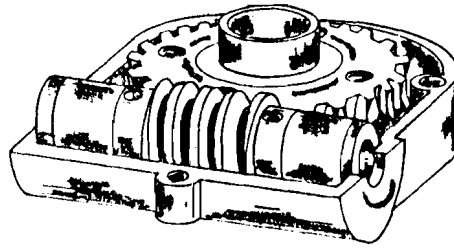

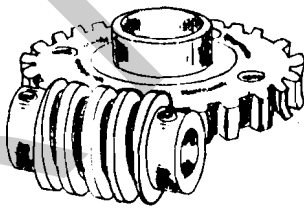
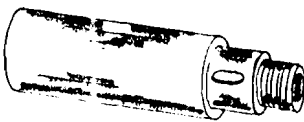
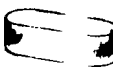
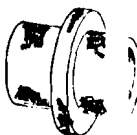



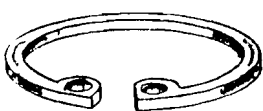

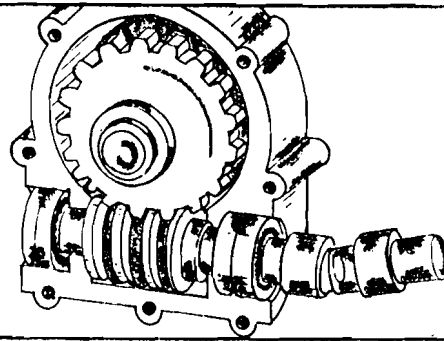
STEPPEX

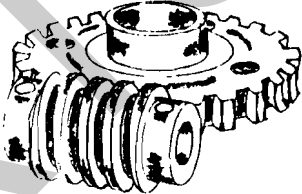
56842	Wellendichtung \varnothing 30/20 x 7	
56844	Wellendichtung \varnothing 40/30 x 7	
56848	Wellendichtung \varnothing 55/30 x 10	
10690	Excenterbüchse	
10691	Excenterbüchse	
		
10709	Welle \varnothing 30	
10768	Mitnehmerscheibe	
		
11342	Schere (gültig bis März 1965)	
11455	Schere (gültig ab April 1965)	
10741	Büchse \varnothing 22/12 x 34.5	
10769	Lagerzapfen mit U- Scheibe und Mutter	



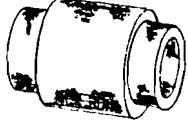

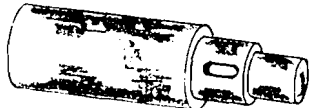

	10053	Nockengetriebe komplett montiert	Bild oben
	12528	Schneckenrad mit Schnecke komplett eingeschliffen	
	10057	Welle zu Schneckenrad	
	11864	Keil zu 10057	
	10059a	Exzenterbüchse	
	10060a	Exzenterbüchse	
	53601	Kugellager $\varnothing 55/30 \times 13$ 6006 R 3	
	56848	Wellendichtung $\varnothing 55/30 \times 10$ R 23	
	56809	Innen Sicherungsring $\varnothing 55 \times 2$	

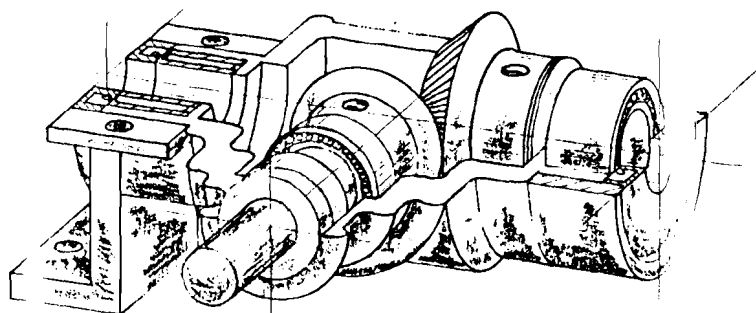

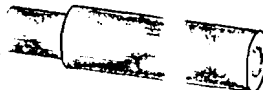
	10111	Transportgetriebe komplett montiert	Bild oben
	12532	Schneckenrad mit Schnecke komplett eingeschliffen	
	10118	Welle zu Schnecke	
	53606	Kugellager $\varnothing 15/32 \times 9$	
	56810	Wellendichtung $\varnothing 15/32 \times 7$	
	56811	Innen Sicherungsring $\varnothing 32 \times 1,2$	
	10120	Büchse	
	10121	Büchse	
	10069a	Schneckenradwelle	
	11863	Kette zu 10069a	

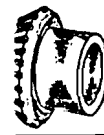
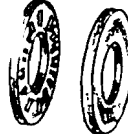
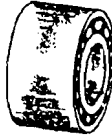

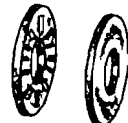

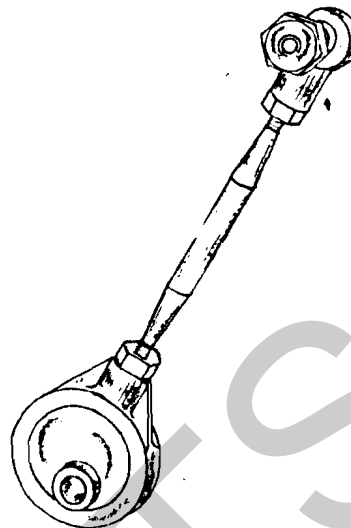



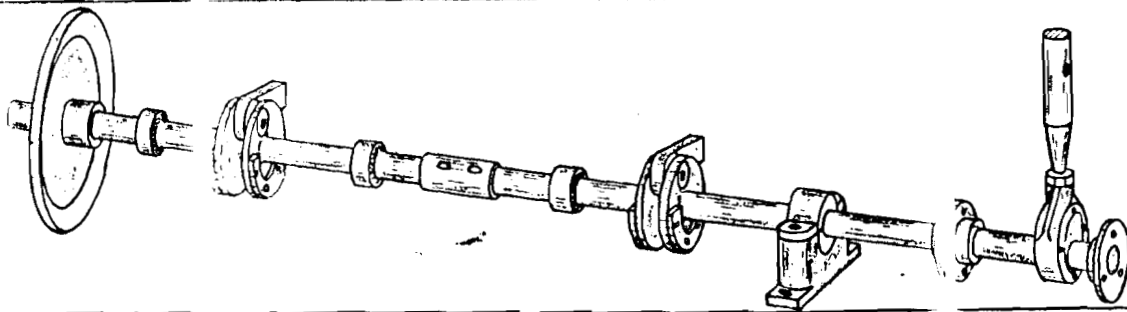

1012	Kegelradgetriebe komplett montiert	Bild ob
10043	Kegelrad	
10070	Achse zu 10043	
53665	Kugellager $\varnothing 32/15 \times 9$	
56845	Wellendichtung $\varnothing 32/15 \times 7$	
10042	Kegelrad	
50002	Axiallager $\varnothing 47/30 \times 5.8$ zu 10042	
54805	Nadelbüchse $\varnothing 42/30 \times 20$	
56843	Wellendichtung $\varnothing 48/30 \times 8$	
10161	Gelenkwelle	
50001	Axiallager $\varnothing 28/15 \times 6.8$ zu 10043	

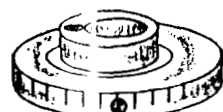



	10188	Nadelexzenter komplett montiert	
59 64 74 100	10090 10481	Nadel - Exzenterstange	
	11152	Sechskantmutter mit Linksgewinde	
	11153	Sechskantmutter mit Rechtsgewinde	
59 64 74 100	11063 11932	Lagerauge komplett montiert mit Lagerzapfen	
59 64 74 100	10262 a 10519	Lagerzapfen zu 11063 mit U-Scheibe und Mutter do zu 11932	



59 64 64 V 64 P 74 100	11060 11058 11061 10875 11059 11181	Kurbelwellensatz komplett montiert	Bild oben
	10136	Pleuelkopf ✓	
	54810	Nadellager zu 10136 ✓	
	10133	Excenterring ✓	
	10134	Excenterring mit Skala ✓	
59,64 74	55601	Pendellager zu Stehlager Ø 72/30 x 17 <i>1207K</i>	
100	55604	Pendellager zu Stehlager Ø 85/40 x 19 <i>1209K SLWA 11209</i>	
59,64 74 100	52001 52011	Filzring zu Stehlager Ø 43/30 x 5 Filzring zu Stehlager Ø 53/40 x 5	
	10373	✓	
59 64 74 100	10713 10475	Flansch Bohrung Ø 30 Flansch Bohrung Ø 40	
59 64 74 100	10714 10530	Flansch Bohrung Ø 30 Flansch Bohrung Ø 40	

STEPPMASCHINEN-ERSATZTEILE
 OEHLER AG AU SG POSTFACH 5 SCHWEIZ

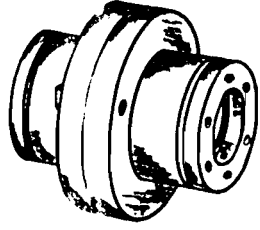
STEPPEX

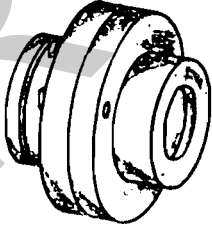

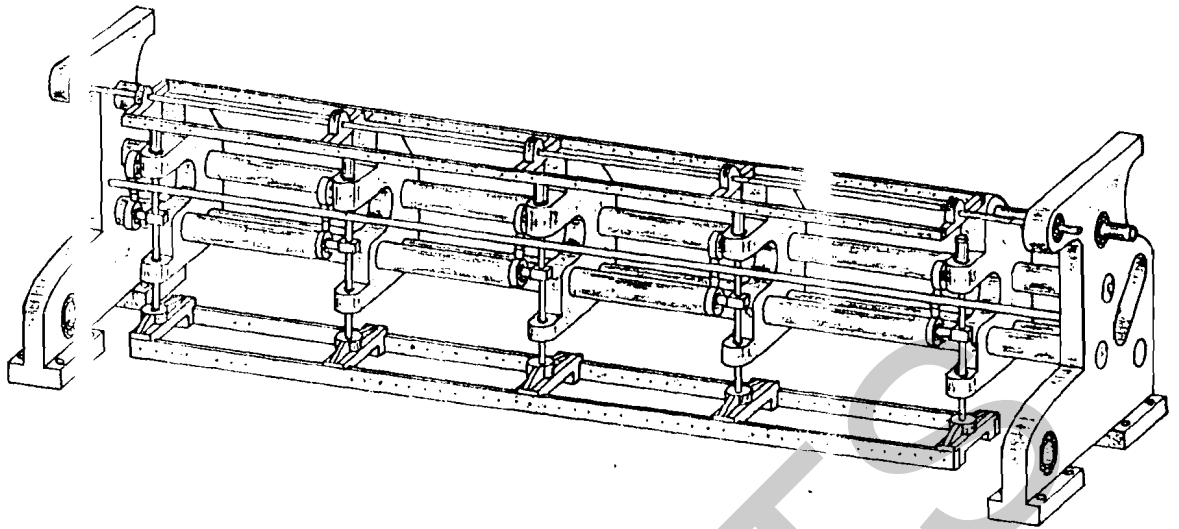





100	12779 12780	Kupplung für Schiffmoment § 30/30 kompl. mit Spannring Ersatz für 10713/10714) Kupplung für Schiffmoment § 30/40 kompl. mit Spannring Ersatz für 10475/10530)	
	12701	Kupplung bei Getriebe \varnothing 30 komplett mit Spannring Ersetzt durch 12820)	
	12820	Kupplung bei Getriebe \varnothing 30/30 komplett mit Spannring Ersatz für 10713/10714) Ersatz für 12701)	

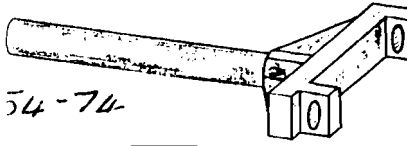
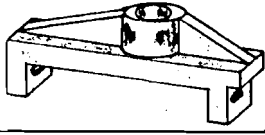

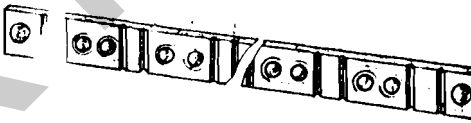
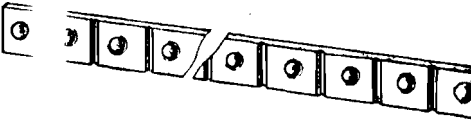
			<p><u>ACHTUNG:</u> Ab Maschine No 800 siehe auch Blatt No 14a</p> <p><u>ATTENTION:</u> Depuis machine No 800 voir aussi feuille 14a</p> <p><u>ATTENTION:</u> From machine No 800 see also page 14a</p>	
59 64 74	5400	**	<p>Längskugellager \varnothing 28/18 x 30</p> <p>** gültig bis Maschine No 246</p>	
	5400	++	<p>Längskugellager \varnothing 28/20 x 30</p> <p>++ gültig ab Maschine No 247</p>	
59 64 74	1106	**	<p>Nadelantriebsrohr mit Brücke montiert</p> <p>** gültig bis Maschine No 246</p>	<p>54-74 + VAT</p>
59 64 74	10015	**	<p>Nadelbrücke</p> <p>** gültig bis Maschine No 246</p>	<p>23-32 TVAT</p>
59 64 74	10410	**	<p>Nadelantriebsrohr</p> <p>** gültig bis Maschine No 246</p>	<p>31-42 + VAT</p>
59 64 74	10361	**	<p>Sinterbronzebüchse unten \varnothing 14/8 x 14</p> <p>** gültig bis Maschine No 246</p>	
59 64 74	10361	**	<p>Sinterbronzebüchse oben \varnothing 14/8 x 14</p> <p>** gültig bis Maschine No 246</p>	

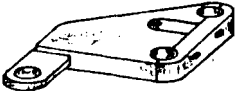

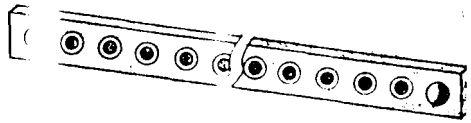

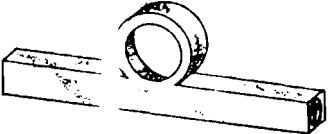

STEPPMASCHINEN-ERSATZTEILE
 OEHLE R AG AU SG POSTFACH 5 SCHWEIZ

12
STEPPEX

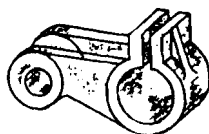
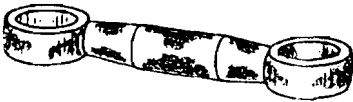
59,64 74 100 59-74T	11078 ++ 11361 11856 ++	Nadelantriebsrohr mit Brücke montiert ++ gültig ab Maschine No 247	 54-74
59,64 74,100 59-74T	11085 ++ 11855 ++	Nadelbrücke ++ gültig ab Maschine No 247	 13-32
59,64 74 100	11082 ++ 11355	Nadelantriebsrohr ++ gültig ab Maschine No 247	 142
	52408 ++	Graphit-Broncebüchse ++ gültig ab Maschine No 247	
59 T 64 T 74 T	11933 11387 11934	Nadellineal Twin Wird nur Paarweise geliefert	
59 64 74 100	10002 10421 10305 10512	Nadellineal Wird nur Paarweise geliefert	
	11091	Nadelschraube	
59 64 74	11000	Mittelstütze	
59,64 64 V 74 100	11388 54819	Ring zu 11000, \varnothing 40/30 x 12 Ring zu 11000, \varnothing 40/35 x 20	
59,64 64 V 74 100	54817 54818	Innenring zu 11000, \varnothing 30/25 x 17 Innenring zu 11000, \varnothing 35/30 x 20	
59 64 74 100	10370 10371 10372 10472	Fadenwippelineal mit 55203	
	55203	Oese zu Fadenwippelineal	
59,64 64 V 74 100	10619 10411	Fadenwippebrücke	

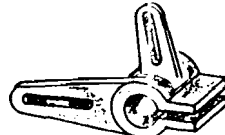
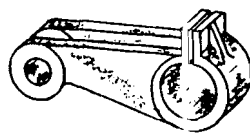
STEPPMASCHINEN-ERSATZTEILE
 OEHLENER AG AU SG POSTFACH 5 SCHWEIZ







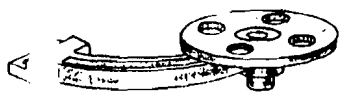

15
STEPPEX

59 64 64 V 74	10018 11298	Fadenwippehebel	
59 64 74 64 P	10033 10836	Pleuel 125 mm Pleuel 150 mm	
	54800	Nadellager zu Pleuel ø 20/10 x 12	
	11935	Rändelbolzen zu 54800 ø 10 x 40	
59 64 64 V 74	10017 11300	Doppelhebel	
59, 64 64 V 74 64 P 100	10019 11299 10900 10454	Nadelantriebshebel	
59 64 74, 100 64 P	10310 10838	Pleuel 100 mm	
	54800	Nadellager zu Pleuel ø 20/10 x 13	
64 V 74	10607	Gegenlager	
64 V 74	53629	Kugellager zu 10607 ø 62/30 x 17	

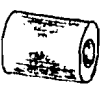
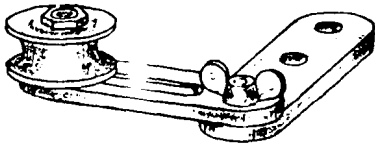
TL4 14124
 I 210 x 13

STEPPMASCHINEN-ERSATZTEILE
 OF HLER AG AU SG POSTFACH 5



NUM 15 14
 CHWEIZ **STEPPEX**

	11051	Aufwellarm mit Poullie komplett montiert	
	53601	Kugellager zu 11051 Ø 55/30 x 13	
	11055	Aufwellarm	
	10390	Nylonrolle zu 11055	
59 64, 74 100 64 V	11052 11381	Riemenspanner komplett montiert	
	55601	Pendellager Ø 72/30 x 17 1207  SHAF 1206	
	52001	Filzring Ø 43/30 x 5	
59 64	55600	Pendellager Ø 62/25 x 16 1206K	
59 64	52000	Filzring Ø 38/ 25 x 5	





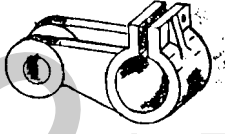
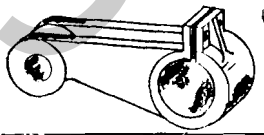
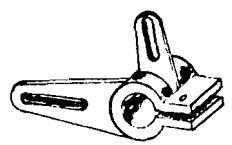
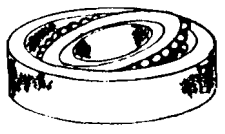

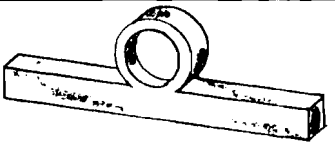
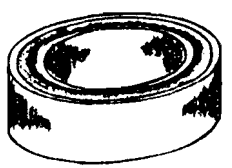
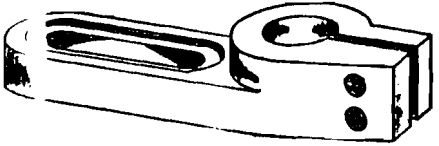
STEPPMASCHINEN-ERSATZTEILE
 OEHLENER AG AU SG POSTFACH 5 SCHWEIZ

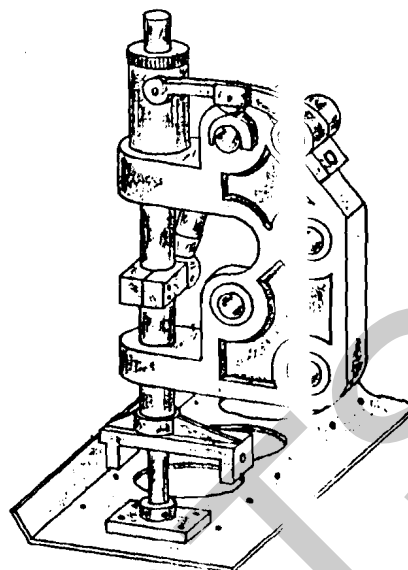
STEPEX

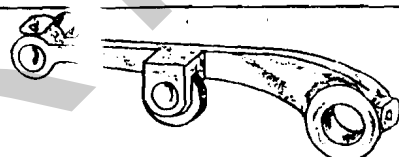
Ab Maschine No 800

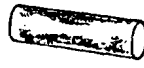
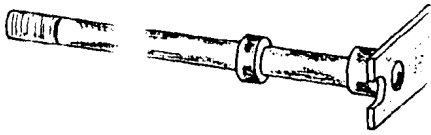

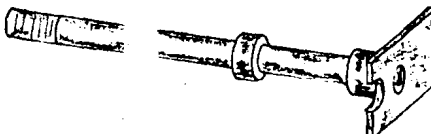



	11298	Fadenwippehebel	
	11299	Nadelantriebshebel	
	11300	Doppelhebel	
	55601	Pendelrollenlager Ø 72/30 x 17	
	52001	Federling Ø 43/30 x 5	
	10411	Fadenwippebrücke	
	54831	Nadellager für Mittelstütze	
100	10456	Fadenwippehebel	
100	11372	Nadelantriebshebel	

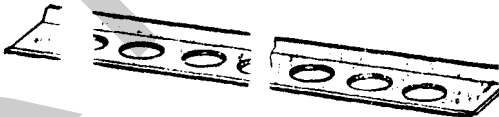
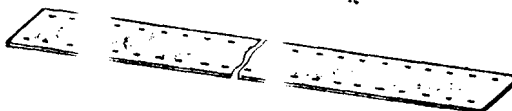

59 64 74	11153	Stoffdrückerhebel	
59 64 74	5360	Kugellager $\varnothing 22/8 \times 7$ zu 11158	
59 64 74	1188	Zylinderstift $\varnothing 8 \times 30$	
59 64 74	11069 **	Stoffdrückerstange komplett mit Fuss $\varnothing 8$ ** gültig bis Maschine No 246	
59 64 74	10360 **	Druckfeder zu 11069 ** gültig bis Maschine No 246	
59 64 74	10298 **	Schraube zu 11068 siehe Seite 11 ** gültig bis Maschine No 246	
59,64 74 64 P 100	11090 ++ 11377	Stoffdrückerstange komplett mit Fuss, $\varnothing 10 \text{ mm}$ ++ gültig ab Maschine No 247	
59,64 74 64 P 100	11088 ++ 11359	Druckfeder zu 11090 Druckfeder zu 11377 ++ gültig ab Maschine No 247	
	11083 ++	Schraube zu 11078, 11361, 11856, siehe Seite 12 ++ gültig ab Maschine No 247	

STEPPMASCHINEN-ERSATZTEILE
 OEHLER AG AU SG POSTFACH 5 SCHWEIZ

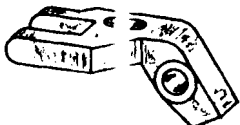

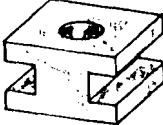
59 64 74	10295	Regulierschraube zu 11069 und 11090	
59 64 74	10296	Deckel zu 10297	
59,64 64V,74 64P 100	11092 10984 10824 10943	Stoffdrückernocke	
59 59 T 64,V 64 P 64 T 74 74 T 100	10021 11942 10422 10821 11943 10302 11944 10511	Stoffdrückerplatte	
59 59 T 64,V,P 64 T 74 74 T 100	10020 11945 10439 11946 10206 11947 10464	Stichlochplatte	
59 64 74	10297	Hülse	
64 P 100	11385	Stoffdrückerhebel	
64 P 100	SM 12/71 ø 12 x 30	Zylinderstift ø 12 x 30	
64 P 100	11360	Mitnehmer	

STEPPMASCHINEN-ERSATZTEIL
 OEHLER AG AU SG POSTFACH 5 SCHWEIZ

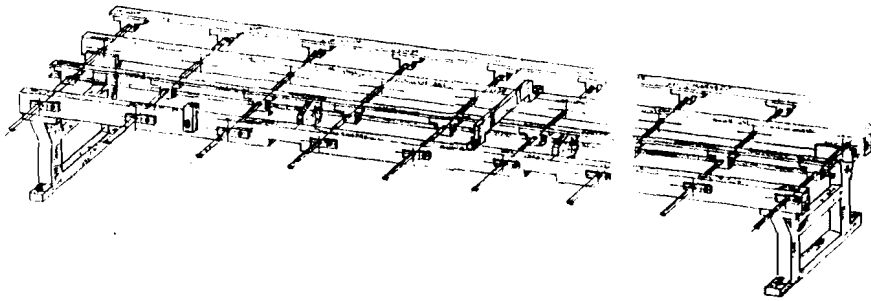

	10201	Antriebsrohr $\varnothing 12.6/8 \times 366$ <i>16 1/2 LONG</i>	
	54006	Längskugellager zu 10201 $\varnothing 22.1/12.6 \times 30$	
	52003 52010	Filzhalter zu 10201 Filzring $\varnothing 20/12 \times 5$	
	10689	Klemme vorne	
	10688	Klemme hinten	
59 64 74 100	10162 10433 10340 10508	Schiffantriebswelle $\varnothing 12$ <i>10 1/2 LONG</i>	
	11054 ✓	Lagerauge komplett montiert für Schiffantrieb	
100	10142 10124 ✓	Pleuelstange zu 11054 Pleuelstange zu 11054	
	11150 ✓ 11151 ✓	Sechskantmutter links zu 10142 Sechskantmutter rechts zu 10142	
	11057	Stützrolle montiert für Einführblech	

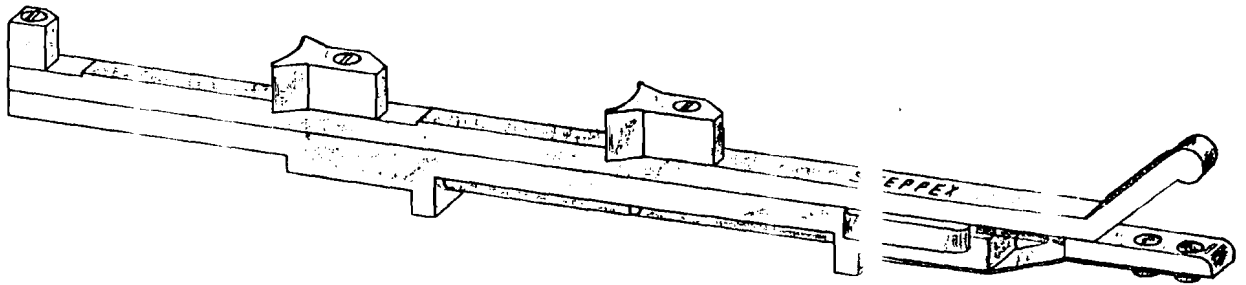

59,64 64V,P 74 100	10685	Schiffhalter montiert wird immer mit 11075 geliefert	Bild oben
	10620	Schiffhalter-Unterteil	
	10623	Kappe hinten	
	10622	Kappe vorne	
	11075	Feder mit Klinke montiert	
	10587	Klinke	
	10586	Flachfeder	
59 64 74 100	10731 10732 10733 10734	Treiberlineal vorne	
59 64 74 100	11875 11376 11377 11378	Treiberlineal hinten	
T	10046 11308	Schiffsteg	

24 30

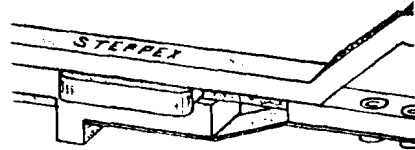
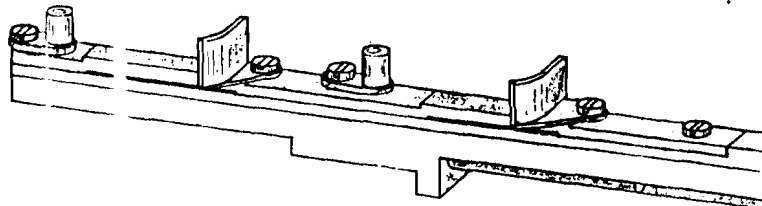

Nur für TWIN-MASCHINEN

59 T 64 T 74 T	1865	Schiffhalter Twin montiert rechts - rechts
	10620	Schiffhalter - Unterteil
59 T 64 T 74 T	11866	Schiffhalter - Oberteil Twin montiert, links - links
59 T 64 T 74 T	11867	Schiffhalter - Oberteil Twin rechts - links montiert
59 T 64 T 74 T	11868	Schiffhalter - Oberteil Twin links - rechts montiert
59 T 64 T 74 T	11167	Treiberstift vorne montiert
59 T 64 T 74 T	11869	Schraube mit Federring M 3.5 x 12 zu 11167
59 T 64 T 74 T	11870	Bügel Twin rechts
59 T 64 T 74 T	11871	Bügel Twin links
59 T 64 T 74 T	11872	Schraube mit Federring und Scheibe M 3.5 x 12 zu 11870/11871

Bild oben

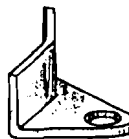
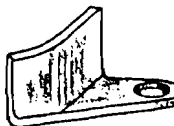
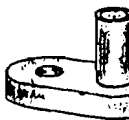
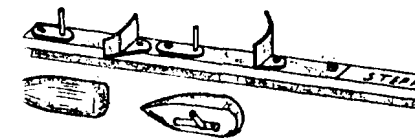
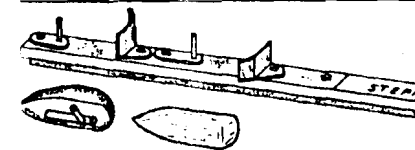
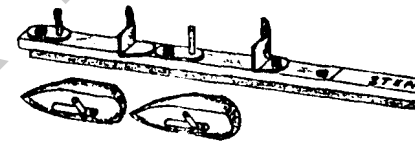

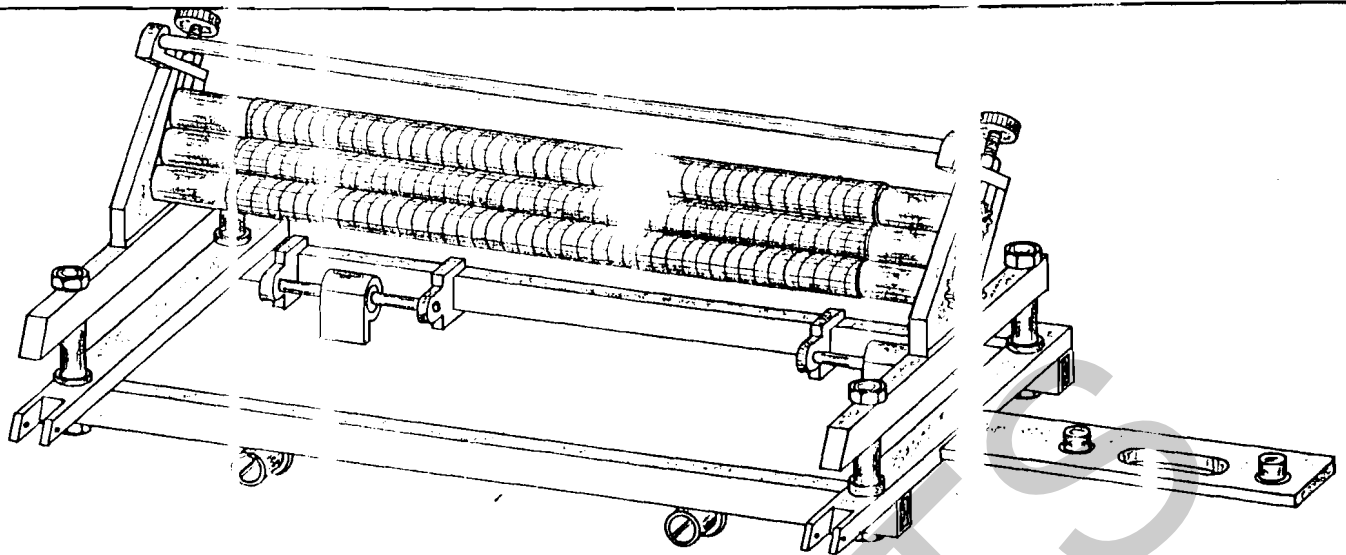





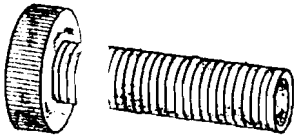

59 64 74 100	10014 10459	Gabel	
59 64 74	10051	Deckplatte zu 10014	
59 64 74	10109	Gabelbefestigung rechts zu 10014	
59 64 74	10110	Gabelbefestigung links zu 10014	
	10044	Transportwalzenbüchse unten links und rechts zu 10014/10459	
	10045	Transportwalzenbüchse mitte und oben, rechts zu 10014/10459	
	10045	Transportwalzenbüchse mitte und oben, links zu 10014/10459	
	10737	Transportwalzenbüchse oben links, für Meterzähler zu 10014/10459	
59,64 74 64 P 100	10448 10533	Stirnrad	

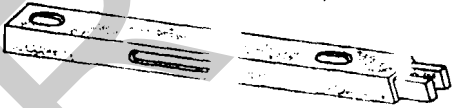
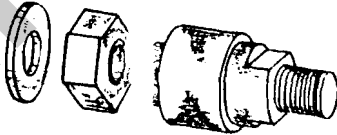
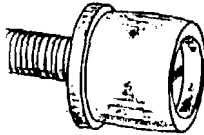
STEPPEXMASCHINEN-ERSATZTEILE
 OEHLER AG AU SG POSTFACH 5 SCHWEIZ

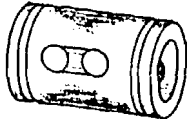
STEPPEX

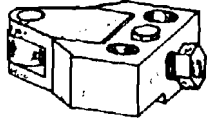
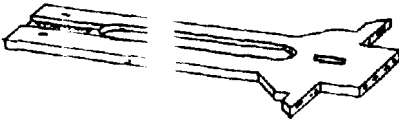
	51211	Distanzscheibe für Transportwalzen, $\varnothing 47/30 \times \dots$ (bei Bestellung Dicke angeben)	
	10048	Regulierschraube	
	10546	Druckfeder zu 10048	
59 64, 4	10049	Druckbolzen zu 10048	
64 10	11004	Druckbolzen zu 10048	
59 64 74 S	10405 a	Wagen-Querrohr unten rechts	
59 64 74 S	11074	Nocken-Fühlerrolle mit U-Scheibe und Mutter für Standard-Maschinen	
59 64 74	11064	Nylonrolle montiert für Wagen, vorne	
	10150	Welle zu Wagenlager	
	54004	Längskugellager zu 10150 $\varnothing 38/25$	
	52000	Filzring $\varnothing 38/25 \times 5$	
	11162	Nockenfederfühler komplett	
S	10095	Steuerplatte	

STIEPPMASCHINEN-ERSATZTEILE
 OEHLER AG AU SG POSTFACH 5 SCHWEIZ



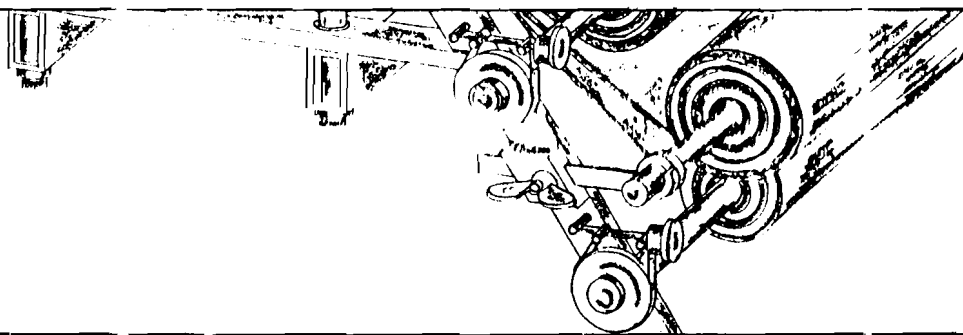



STEPPEX

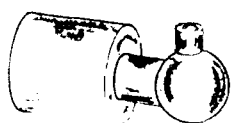
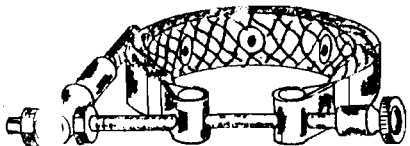

100	11921 11885	Stoffwellenlager, rechts, mit Schloss, komplett montiert	
100	11920 11885	Stoffwellenlager, links komplett montiert	
		siehe Hubmagnet Blatt 28	
ST/SA 100 ST/SA 100	54400 54407 54403 54409 12470	Meterzähler Meterzähler Yardzähler Yardzähler Befestigungsplatte	<p>116</p>
	10570 10600 12710 11020	Stoffwellenkeil \varnothing 31 Stoffwellenkeil \varnothing 36 Stoffwellenkeil \varnothing 41 Stoffwellenkeil \varnothing 49	
100	1028 11028	Kugelzapfen \varnothing 26 Kugelzapfen \varnothing 40	
100	10280 11027	Winkelzapfen \varnothing 26 Winkelzapfen \varnothing 40	



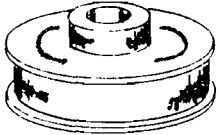
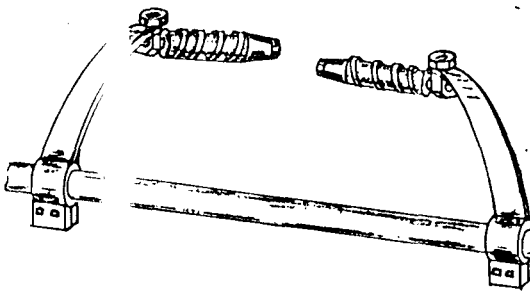
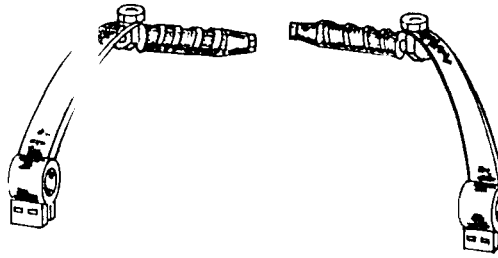



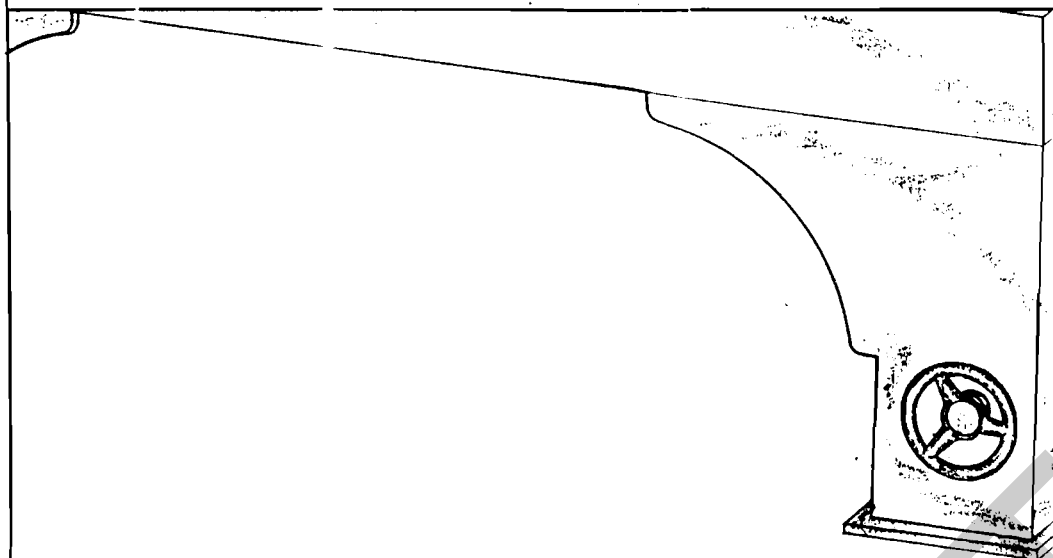
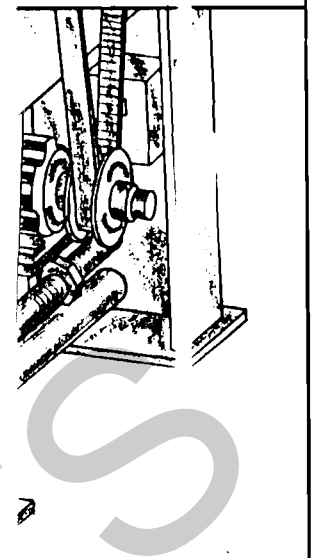

STEPPMASCHINEN ERSATZTEILE
OEHLER AG AU SG POSTFACH 5 SCHWEIZ

STEPPEX

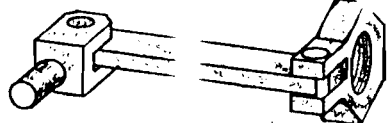
100	11188	Kugelzapfen für Hubmagnet Ø 26 Kugelzapfen für Hubmagnet Ø 40 Bei Bestellung Ø angeben	
100	10545 11148	Bremsband komplett montiert	
	10543	Gewinde-Spindel zu 10545/11948	
	11823	Rändelmutter zu 10545/11948	
100	10071 10906	Fixierbolzen	
	11371	Bremsstrommel	
	12535	Breithalter komplett Maschinengrösse angeben	
	12557 12558	Breithalter rechts Breithalter links	
	12567	Breithalter mit Lasche	

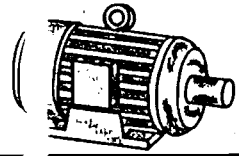
STAPPMASCHINEN-ERSATZTEILE
 OEHLER AG AU SG POSTFACH 5 SCHWEIZ



STAPP

					
	52800	Handrad			
59,64 74	10293	Spindel			
100	10535				
	10294	Motorverstellungsgelenk komplett montiert			
59,64 74	10101	Motorplatte			
100	10908				
59,64 74	54403	Motor			
100	54405	Motor			
59,64 74	56803	Spreizscheibe 1:3 zu 54403 \varnothing 24			
100	56852	do zu 54405 Bei Bestellung \varnothing Bohrung angeben			
59,64 74	56859	Spreizscheibe, Bohrung \varnothing 22 zu 54403			
59,64 74	10004 a	Achse zu 10101			
100	10536	Achse zu 10908			
59,64 74	56401	Antriebsriemen			
100	56406	bis Maschine No 548			
100	56425	ab Maschine No 549			



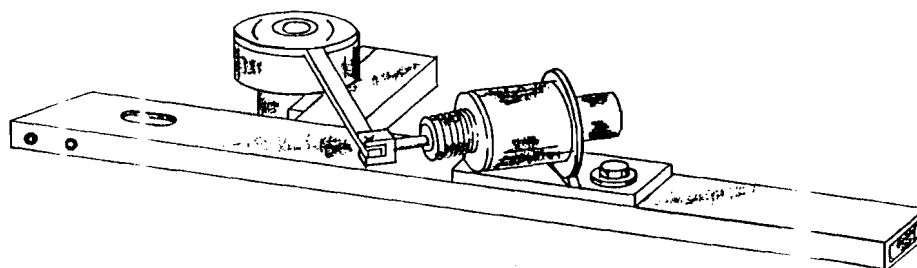

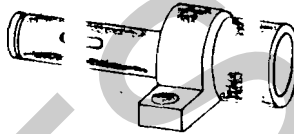

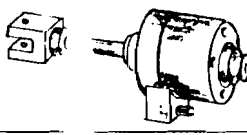
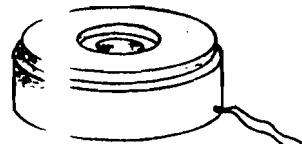
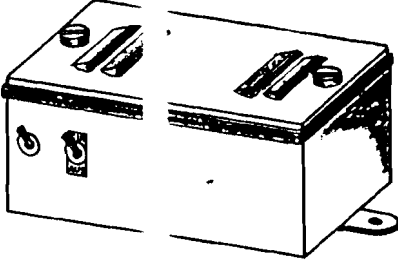
STEPPMASCHINEN-ERSATZTEILE
 OEHLE AG AU SG POSTFACH 5 SCHWEIZ

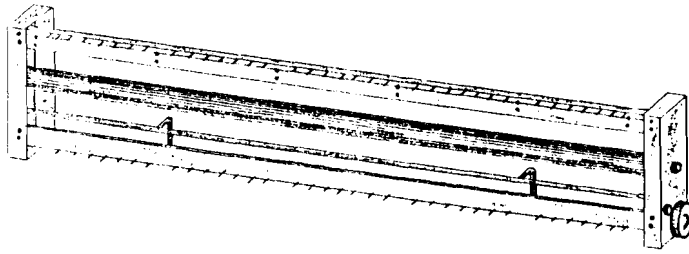
STEPPEX

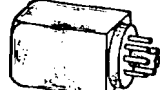

100	12538 12539	Lagerbock komplett montiert	
100	53628 53624	Kugellager $\varnothing 20/42 \times 12$ 2RS $\varnothing 30/55 \times 13$ 2RS	
	51217	Druckfeder	
	52808	Huf magnet	
	12420	Einscheiben-Kupplung	
SA K	56813 56971	Transformator SSG 8 220/24 V Transformator SSG 8RT 220/24 V	

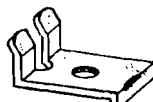

58400	Walzenbelag mit Klebstoff Bei Bestellung Maschinentyp angeben	
52004	Steuerkasten zu Fadenwächter	
52012	Relais zu Fadenwächter	
52014	Röhre zu Fadenwächter	
52020	Fadenwächter-Schraube zu 52018	
52019	U - Scheibe zu 52020	
52016	Druckfeder zu 52018	
52018	Druckplättchen	
52015	Kontaktfeder	